



RGBU15005 thru RGBU1510

15 A, Fast Recovery Glass Passivated Bridge Rectifier

Rectifier Reverse Voltage 50 to 1000V

Features

- Ideal for printed circuit board mounting
- This series is UL listed under the Recognized Component Index, file number E484648
- The plastic material used carries Underwriters Laboratory flammability recognition 94V-0
- Built-in printed circuit board stand-offs
- High case dielectric strength
- High temperature soldering guaranteed 260°C /5 seconds at 5 lbs (2.3kg) tension

Mechanical Data

Case: Reliable low cost construction utilizing molded plastic technique

Terminals: Plated leads solderable per MIL-STD-202, Method 208

Mounting Position: Any

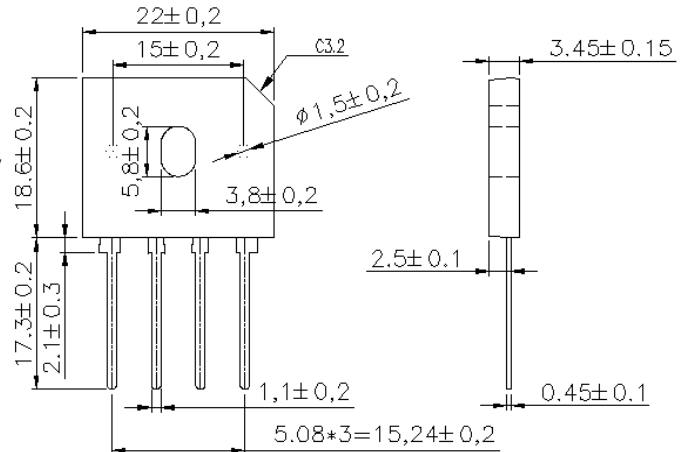

Dimensions in inches and (millimeters)

Maximum Ratings & Thermal Characteristics

Rating at 25°C ambient temperature unless otherwise specified, Resistive or Inductive load, 60 Hz.
For Capacitive load derate current by 20%.

Parameter	Symbol	RGBU 15005	RGBU 1501	RGBU 1502	RGBU 1504	RGBU 1506	RGBU 1508	RGBU 1510	unit
Maximum repetitive peak reverse voltage	VRRM	50	100	200	400	600	800	1000	V
Maximum RMS bridge input voltage	VRMS	35	70	140	280	420	560	700	V
Maximum DC blocking voltage	VDC	50	100	200	400	600	800	1000	V
Maximum average forward rectified output current at TC=100°C (with heatsink)	IF(AV)	15.0							A
Peak forward surge current single sine-wave superimposed on rated load (JEDEC Method)	IFSM	220							A
Rating for fusing (t<8.3ms)	I ² t	200							A ² sec
Maximum reverse recovery time (Note 2)	t _{rr}	150				250	500		ns
Operating junction and storage temperature range	T _J , T _{STG}	-55 to + 150							°C

Electrical Characteristics

Rating at 25°C ambient temperature unless otherwise specified. Resistive or Inductive load, 60Hz.
For Capacitive load derate by 20 %.

Parameter	Symbol	RGBU 15005	RGBU 1501	RGBU 1502	RGBU 1504	RGBU 1506	RGBU 1508	RGBU 1510	Unit
Maximum instantaneous forward voltage drop per leg at 7.5A	V _F	1.3							V
Maximum DC reverse current at rated TA =25°C DC blocking voltage per element TA =125°C	I _R	10				500		μA	

Notes: (1) Thermal resistance from Junction to Ambient on P.C. board mounting.

(2): Reverse recovery time test conditions: I_F=0.5A, I_R=1.0A, I_{RR}=0.25A

Rating and Characteristic Curves ($T_A=25^{\circ}\text{C}$ Unless otherwise noted)

RGBU15005 thru RGBU1510

Fig. 1 Derating Curve for Output Rectified Current

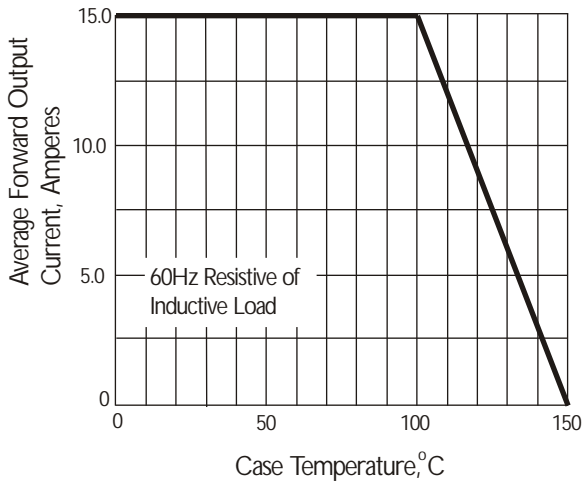

Fig. 2 Maximum Non-repetitive Peak Forward Surge Current

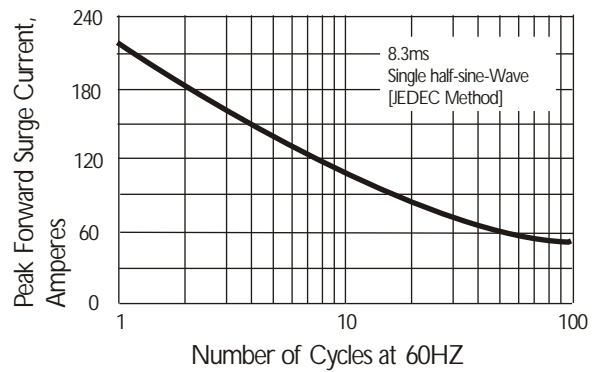

Fig. 3 Typical Instantaneous Forward Characteristics



Fig. 4 Typical Reverse Characteristics



Fig. 5 Typical Junction Capacitance

